



BATTERY CELL INSULATION TESTER MODEL 11210

Chroma 11210 battery cell insulation tester is an instrument used for accurately measuring leakage current (LC) and insulation resistance (IR) of battery jelly-roll/dry-cell as well as various insulation materials. In addition to standard LC/IR measurement, the 11210 has a unique function that detects partial discharge (PD) or flashover that may have occurred inside the insulation material during the high voltage insulation testing process. With PD detection of the battery's internal status before electrolyte filling, defective products can be filtered out before entering the next stage of production preventing the potential hazards that may occur in the field. In contrast to traditional methods of insulation test, Chroma 11210 provides an entirely new concept for inspection and evaluation of battery quality.

With an ample charging current capability, the 11210 can easily achieve high speed testing with automatic execution of the test sequence. The sequence of a regular insulation test in the target application is "Charge→Dwell→Test→Discharge". This sequence can be automatically executed in 20ms or less for a single DUT (Device Under Test); meaning tests performed in the production line can achieve process rates of 50 pcs/sec or more.

Chroma 11210 measures the LC in a wide range, from 10pA to 20mA with 7 ranges of current measurement to enhance the accuracy. The auto-range function is also available for quick and easy operations on a new DUT.

Due to special circuitry used in the Chroma 11210, no extra time is required for the PD detection function. Both LC/IR measurements and PD detection tests can be performed simultaneously and both test results will be reported automatically. Thus, high speed testing at <20ms per DUT is achievable even when both LC/IR and PD tests are being performed.

In a traditional insulation test, contact checking is critical to the reliability of a complete test. No-contact on the DUT is very likely treated as a "pass" during the test, while the real insulation test has not been executed on that DUT yet. Thus, a "false-good" condition could occur and a defective DUT may be passed as good. This is especially true if the insulation resistance of the DUT is extremely high. The contact check function in the Chroma 11210 employs advanced technology to instantly detect those which do not make secure contacts during the tests. It takes only 5ms to do a thorough contact check before and/or after the measurement.

MODEL 11210

KEY FEATURES

- Test voltage : up to 1KV(dc)
- Charge current : 50mA max.
- Wide range of Leakage Current (LC) measurement (10pA ~ 20mA)
- Partial discharge/flashover detection for inspection on potential internal short circuits (option of A112100):
 - PD level and number of occurrence display
 - PD events and V/I waveform monitor
 - Programmable PD level limit setting
 - PD and V/I waveform logging (option of A112101)
- Built-in reliable contact check
- Automatic test with sequence : charge-dwell-measure-discharge
- High speed testing (20ms/device)
- 480x272 pixels full-color display and touch panel for easy operations
- Standard Handler, USB, RS-232, Ethernet interfaces

APPLICATIONS

- Lithium Ion Battery (LIB) cell insulation test (tests on dry cell unit)
- Insulation tests on various types of capacitors or any sorts of insulation materials



Chroma

SAFETY ISSUES OF LITHIUM ION BATTERY

The most dangerous condition of the internal short circuits is the **HEAT** generated in localized area inside the cell, which is caused by the short circuit between the aluminum positive electrode and the material coated on the negative electrode. Such kind of battery explosion is the main culprit of several car burning accidents in the past decade. [Figure 1]



[Figure 1] Car burning accident due to battery explosion (descriptive drawing)

Consequences from fire or explosion of lithium ion batteries (LIB) is an increasing concern. As technology advances, the energy density of the LIB increases posing a further risk to consumers. In order to eliminate the risk of fire or explosion, the root cause must be resolved and the defective units must be filtered out before they reach the consumer market. Recent research indicates that internal short circuits between the positive electrode (aluminum) and the material coated on the negative electrode (anode) inside the cell is the root cause of the fire or explosion [Figure 2]. Burrs on the metal electrodes or contaminated particles inside the separator can cause this kind of internal short circuit. [Figure 3].

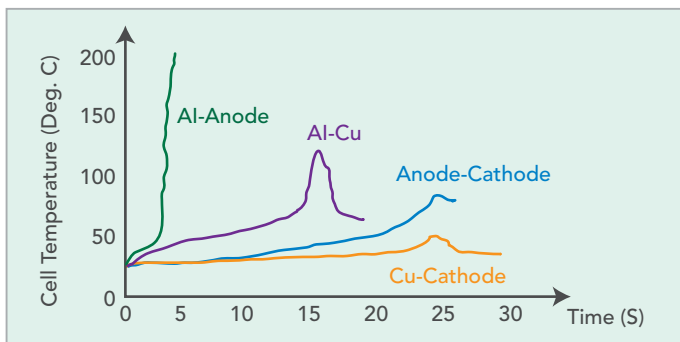

[Figure 2] Temperature rising of different internal short circuit scenarios

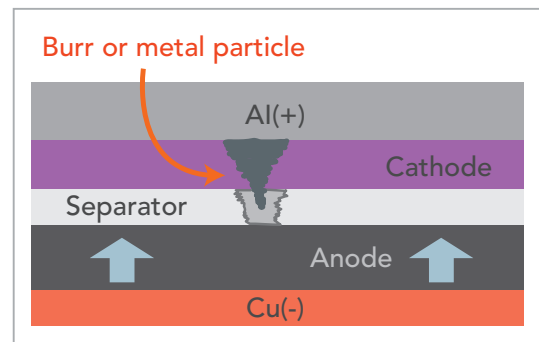

[Figure 3] A burr extruded from the positive electrode may touch the material coated on the negative electrode and eventually cause the disaster.

The research also shows that the material coated on the negative electrode (typically graphite) would expand during the charging phase, expanding up to 24% or more as the charge/discharge cycle repeats. It could continue to expand until the burrs on the aluminum plate finally touch the graphite coated on the negative electrode and result in fire disaster [Figure 4]. There are usually several charge/discharge cycles carried out on the battery cells in the factory before shipping. Let's take an example, two cases of defective cells are present in the production line, and each has a single burr with different height or length on its aluminum plate [case 1 & case 2 in Figure 5]. Case 1 will be detected at the second charging cycle in the factory, since the burr touches to the anode then. However, in most cases, the second one will not be detected until many more charging cycles later, which is very likely to happen after it reaches the consumer.

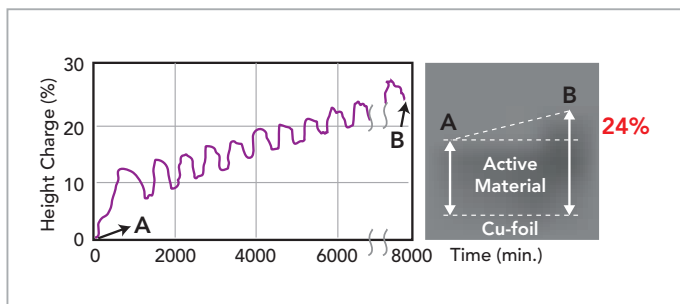

[Figure 4] Real lab experiments show that 24% increase of the graphite material (coating on the negative electrode) may happen after only 10 cycles of charging/discharging.

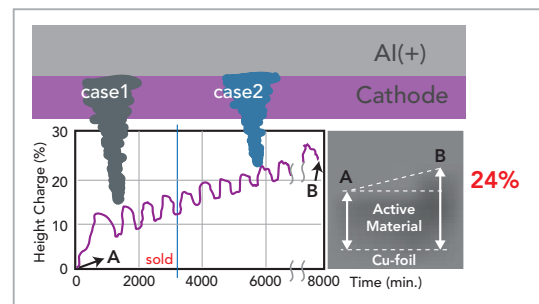

[Figure 5] Two burrs (case 1 & case 2) with different height extruded out from the aluminum positive electrode may cause internal short circuits in different time.

PD DETECTION AND MEASUREMENT FUNCTION

The Partial Discharge (PD) detection function of Chroma 11210 has the ability to detect those defects inside the battery cells in the dry cell stage prior to electrolyte filling. When there are burrs on the electrode metal sheet or defects (impurity particles) inside the insulation layer (the separator sheet) in the dry cells, the insulation distance left between them is shortened but not shorted. In most cases, they cannot be detected by regular insulation LC/IR tests, since the internal short circuit does not exist at the time of executing the tests. The 11210 is the only instrument that can help you to detect possible shorts in the very early phase before any failures can occur. With the proper test voltage applied and the proper PD threshold level set, the 11210 can help you to "measure" the "effective distance" left between the negative electrode and the graphite material (see equation and explanation on the right).

$$E = V/d, E_{max} = V_{max}/d$$

The maximum insulation capability of a certain material is the maximum electrical field it can withstand, which is the quotient of the voltage divided by the distance. Thus, with the known characteristic (E_{max}) of a certain insulation material and the voltage applied, we know the distance left inside the material.

Chroma 11210 battery cell insulation tester detects any PD or flashover that may occur inside the battery cells. There are two phases of detection that the 11210 employs with different circuitries used. The first phase is in CC (Constant Current) mode when the 11210 charges the DUT with a constant current set by the user. During this mode, the 11210 will monitor the voltage level and its slope. Any glitches on the voltage slope or any unexpected changes of the slope will be detected by the 11210 and reported as PD occurrences (shown as ⚡V). The second phase is in CV (Constant Voltage) mode. In this mode, only a stable leakage current should exist. Thus any unusual and protruding pulses on the current waveform are typically the result of an abnormal discharge (i.e. PD or flashover) which will also be detected and reported by the 11210 as a PD occurrence (shown as ⚡I). Chroma 11210 not only detects, but also roughly measures the magnitude of the PD pulses during these modes (Note *1). [Refer to Figure 6 for illustration].

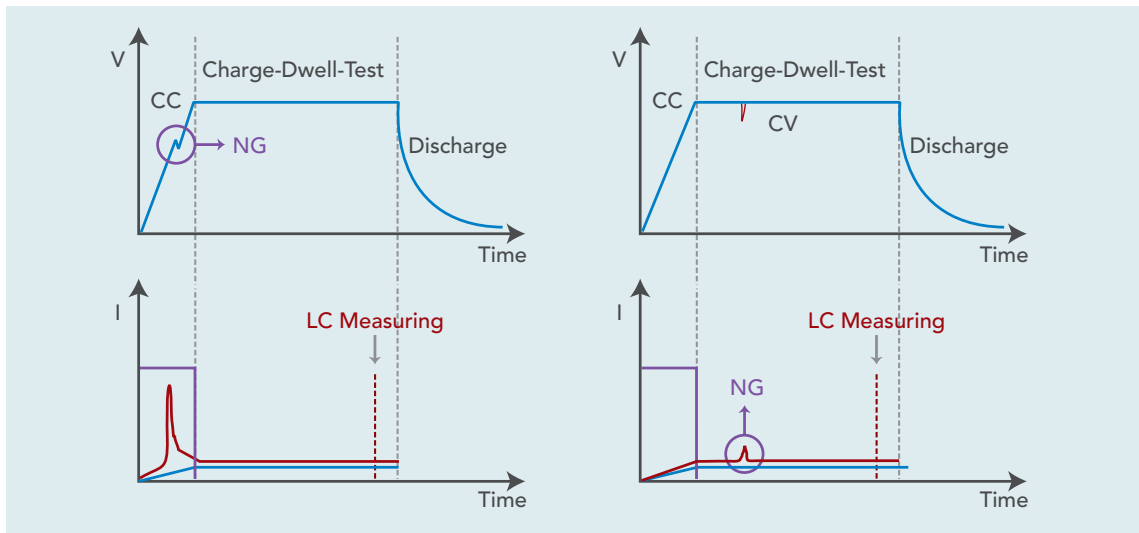

[Figure 6] PD/Flashover detection in both the CC (charging) & CV (measurement) phase

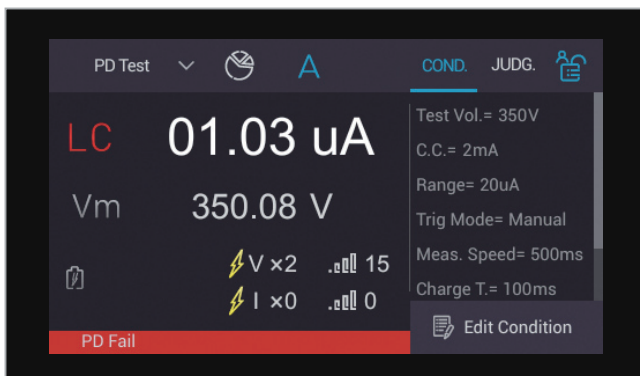

[Figure 7] PD detected in CC & CV mode and reported by 11210

Whether in CC mode or CV mode, the 11210 is able to detect the number of occurrences of those PD events, up to 99 counts [Figure 7]. Either the magnitude or the number of occurrences or both can be set as a threshold level for pass/fail criteria, which is very helpful when testing various devices with different characteristics in the production line.

Note *1 : The measurement of discharge quantity in PD pulses is most accurate when pulse duration is shorter than 100us, and the time interval between consecutive pulses is larger than 300us.

Due to superior PD detection and measurement capabilities, Chroma 11210 can accomplish tasks that a regular LC/IR meter or a hipot tester cannot. A regular LC/IR meter or hipot tester is only able to measure the average value of the leakage current within a certain time interval, but is not able to monitor every detail in the voltage and current waveform. Furthermore, the 11210 provides ultra-stable test voltage with ripple and noise of some mini-volt only, which enables it to look for very minor glitches on the voltage or current waveform. [Figure 8] shows you that without looking into the details of the voltage waveform, minor PD or flashover inside the DUT cannot be detected.

In case the engineering staff needs to review the actual voltage and current waveform on a failed DUT (failure due to PD) after tests are completed, Chroma 11210 offers an advanced option that can store both voltage and current waveforms from each individual device's test. Zooming functions allow users to view waveform details of the PD events easily. And since they are captured and recorded, additional analysis and research can be performed by R&D and/or QA departments.

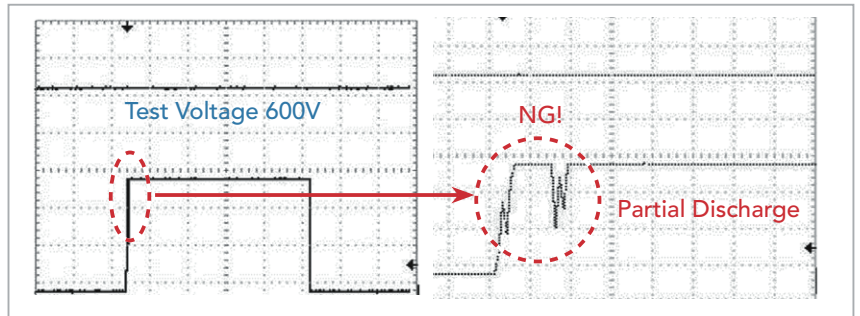

[Figure 8] Without looking into the details of the voltage waveform (left picture), you see nothing abnormal. With Chroma 11210 looking into the details, we can observe two PD events occurred, one in CC mode, the other in nearby CV mode (right picture).

CAPACITOR TEST APPLICATIONS WITH 11210

Chroma 11210 is the next generation and advanced version of its predecessor the 11200 capacitor LC/IR meter. The 11210 includes more versatile functions with higher accuracy, however, retains all the major functions and capabilities found in the 11200. Therefore, the 11210 is also an advanced LC/IR meter for all types of capacitors [Figure 9].

In the production line, the 11210 is able to test capacitors at a very high speed (~20ms per DUT) with appropriate fixtures. Moreover, it has a very wide range of LC/IR measurement with excellent accuracy. Chroma 11210 is the new standard insulation inspection and test instrument for all capacitor production lines.

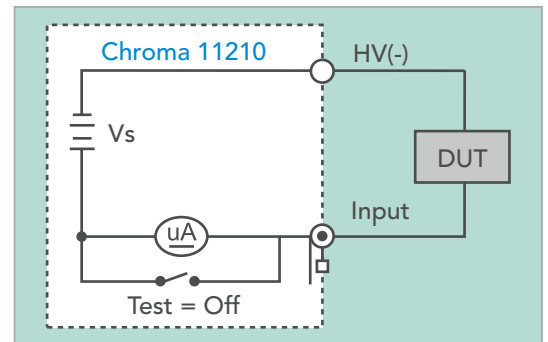

[Figure 9] Block diagram of LC/IR measurement test by 11210 for the DUT of capacitors

Though the PD detection function is specifically designed for the insulation inspection of battery dry cell, it also provides a clear picture of what's going on inside a capacitor during the tests. And with the data collected from the 11210, users can further enhance or improve the insulation quality ensuring the highest quality of insulation is achieved.

As mentioned previously, in a typical insulation test, 4 phases are executed in sequence, which are "Charge→Dwell→Test→Discharge" [Figure 10]. Chroma 11210 allows the users to program the time interval required for the first 3 phases respectively. Each can be set in the range of 5ms to 9.999sec. The phase of "Dwell" is particularly important. For large and pure resistive devices or capacitors with large capacitance but low insulation resistance, the user must allow sufficient "Dwell" time before the actual measurement takes place. The long "Dwell" time is necessary to let the charging current settle down so that it will not affect the leakage current measurement. The 11210 is extremely flexible in these parameters programming, and is able to execute those 4 phases in sequence automatically. For capacitor production testing, Chroma has the knowledge and technologies to assist customers in setting up a reliable inline test or provide a complete turnkey test solution.

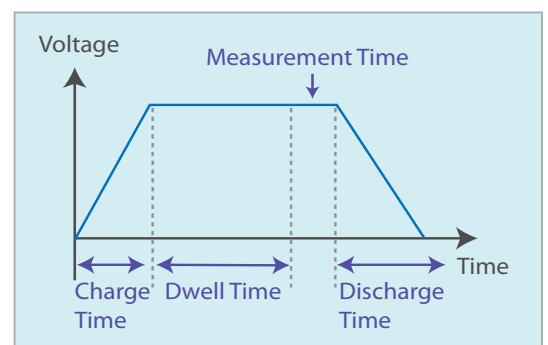

[Figure 10] Timing & sequence of the regular insulation test

SPECIFICATIONS

Model	11210	
Main Functions	Insulation Resistance (IR) Leakage Current (LC) measurement Partial Discharge(PD)* detection (option)	
Output Specifications		
Output Voltage	1.0V ~ 100V, step 0.1V 101V ~ 1000V, step 1V Accuracy: $\pm(0.5\% \text{ Setting} + 0.5\% \text{ Range})$	
Charging Current	0.5mA ~ 50mA, step 0.5mA Accuracy: $\pm(1.5\% \text{ Setting} + 1.5\% \text{ Range})$	
Measurement Display Range		
IR (Insulation Resistance)	0.01k Ω ~ 10 T Ω [k Ω , M Ω , G Ω]	
LC (Leakage Current)	00.00nA ~ 20.00mA [nA, uA, mA]	
Basic Measurement Accuracy		
LC	20.00nA	$\pm(5.0\% \text{ Reading} + 5.0\% \text{ Range})$ [Note 1]
	200.0nA	$\pm(1.0\% \text{ Reading} + 1.0\% \text{ Range})$ [Note 1]
	2.000uA	$\pm(0.3\% \text{ Reading} + 0.3\% \text{ Range})$ [Note 1]
	20.00uA	$\pm(0.3\% \text{ Reading} + 0.3\% \text{ Range})$ [Note 1]
	200.0uA	$\pm(0.3\% \text{ Reading} + 0.3\% \text{ Range})$ [Note 1]
	2.000mA	$\pm(0.3\% \text{ Reading} + 0.3\% \text{ Range})$ [Note 1]
	20.00mA	$\pm(0.3\% \text{ Reading} + 0.3\% \text{ Range})$ [Note 1]
Vmea	100V	$\pm(0.3\% \text{ Reading} + 0.3\% \text{ Range})$ [Note 1]
	1000V	$\pm(0.3\% \text{ Reading} + 0.3\% \text{ Range})$ [Note 1]
IR	Defined by LC and Vmea measurement accuracy	
LC Range	20nA, 200nA, 2uA, 20uA, 200uA, 2mA, 20mA; Auto-Range (automatically range selection)	
Test Time Setting		
Charge	0.005s ~ 9.999s, step 0.001s	
Dwell	0.005s ~ 9.999s, step 0.001s	
Test	0.005s ~ 9.999s, step 0.001s	
L.C. Measurement Integration Time Setting		
Integration Time	1ms	
	4ms	
	1PLC (50Hz: 20ms ; 60Hz: 16.6ms)	
	100ms	
	500ms	
	User define (5ms ~ 9.999s)	
PD Detection (with option of A112100)		
Magnitude Detected	Level 0 ~ 99	
Number of Occurrence	0 ~ 99	
Type of PD Occurrence	VPD (PD occurred in CC mode) CPD (PD occurred in CV mode)	
Judgement Criteria	Magnitude or the number of occurrence or both	
PD Analyzer (with option of A112101)		
Waveform Display	Both voltage and current waveform	
Quick Shot (image) of PD Occurrence	Up to 10 shots (image) per test can be recorded	
Max. Sampling Rate	5MHz	
Sub Functions		
Correction	Null cancellation function (open circuit)	
Comparator	Upper limit, lower limit for LC/IR measurement	
Contact Check	$\leq 5\text{ms}$, pre-test, post-test or both.	
Interface	Ethernet, Handler, RS-232, USB-Host (front panel), USB-Device (rear panel)	
Mechanical and General Specifications		
Operation Environment	Temperature : 0°C ~ 40°C ; Humidity : 10% ~ 90% RH	
Input Power Requirement	90Vac ~ 132Vac or 180Vac ~ 264Vac ; 47Hz ~ 63Hz	
Power Consumption	300 VA	
Outline Dimension (H x W x D)	100 x 320 x 400 mm	
Weight	10 Kg	

Note 1: Conditions of basic measurement accuracy

- Within 1 year after factory calibration
- Temperature: 23°C \pm 5°C; Relative humidity: 75% maximum
- Warm up: 30 minutes minimum
- Test condition for all accuracy : measurement speed with integration time of 500ms
- Guarantee only for the tests on pure resistive DUT

All specifications are subject to change without notice.

PANEL DESCRIPTION

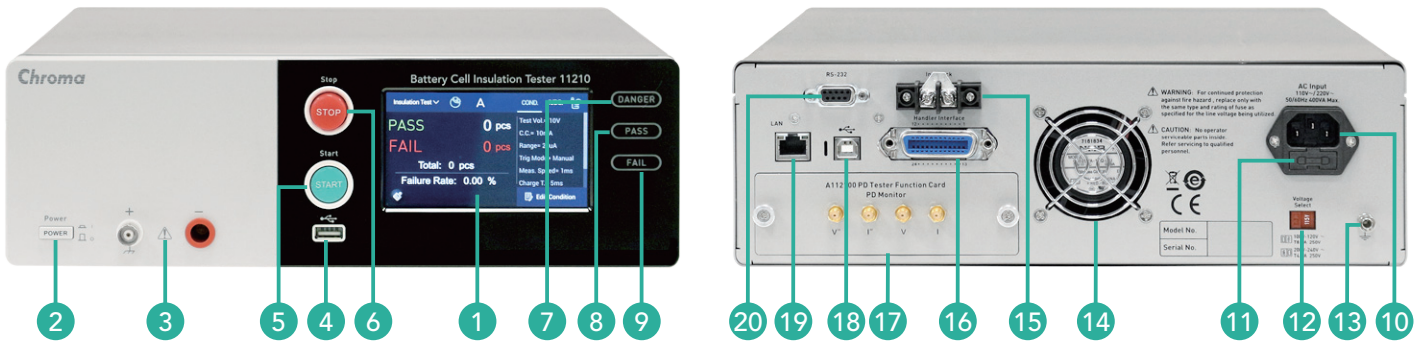

- | | |
|---|---|
| <ul style="list-style-type: none"> 1. Touch panel display 2. Power button 3. High voltage output terminals 4. USB (host) interface (A-type) 5. Start button (starting the test) 6. Stop button (stopping the test) 7. DANGER indicator 8. PASS indicator 9. FAIL indicator | <ul style="list-style-type: none"> 10. AC power input 11. AC input Fuse 12. Input voltage range selector 13. Grounding terminal 14. Ventilation fan 15. Interlock protection terminals 16. Handler interface (Amphenol 57-30240 type) 17. PD tester/PD analyzer card slot (option) 18. USB (device) interface (B-type) 19. Ethernet interface (RJ-45) 20. RS-232 interface (D-sub 9-pin) |
|---|---|

ORDERING INFORMATION

11210 : Battery Cell Insulation Tester
 A112100 : Partial Discharge Detection Card
 A112101 : Partial Discharge Analyzer Card
 A112102 : PD Test Checking Kit

Get more information by downloading Chroma ATE Solutions APP



iOS





Android

Search Keyword

11210

HEADQUARTERS
 CHROMA ATE INC.
 66 Huaya 1st Road,
 Guishan, Taoyuan
 33383, Taiwan
 T +886-3-327-9999
 F +886-3-327-8898
 www.chromaate.com
 info@chromaate.com

U.S.A.
 CHROMA SYSTEMS
 SOLUTIONS, INC.
 19772 Pauling,
 Foothill Ranch,
 CA 92610
 T +1-949-600-6400
 F +1-949-600-6401
 www.chromausa.com
 sales@chromausa.com

EUROPE
 CHROMA ATE
 EUROPE B.V.
 Morsestraat 32,
 6716 AH Ede,
 The Netherlands
 T +31-318-648282
 F +31-318-648288
 www.chroma.eu.com
 sales@chroma.eu.com

CHROMA ATE GERMANY
 Südtiroler Str. 9, 86165,
 Augsburg, Germany
 T +49-821-790967-0
 F +49-821-790967-600
 support-germany@chroma.eu.com

JAPAN
 CHROMA JAPAN
 CORP.
 888 Nippa-cho,
 Kouhoku-ku,
 Yokohama-shi,
 Kanagawa,
 223-0057 Japan
 T +81-45-542-1118
 F +81-45-542-1080
 www.chroma.co.jp
 info@chroma.co.jp

KOREA
 CHROMA ATE
 KOREA BRANCH
 3F Richtgether
 Center, 14,
 Pangyoyeok-ro 192,
 Bundang-gu,
 Seongnam-si,
 Gyeonggi-do
 13524, Korea
 T +82-31-781-1025
 F +82-31-8017-6614
 www.chromaate.com
 erica.shih@chromaate.co.kr

CHINA
 CHROMA ELECTRONICS
 (SHENZHEN) CO., LTD.
 8F, No.4, Nanyou Tian
 An Industrial Estate,
 Shenzhen, China
 T +86-755-2664-4598
 F +86-755-2641-9620
 www.chroma.com.cn
 info@chromaate.com

SOUTHEAST ASIA
 QUANTEL PTE LTD.
 (A company of Chroma Group)
 46 Lorong 17 Geylang # 05-02
 Enterprise Industrial Building,
 Singapore 388568
 T +65-6745-3200
 F +65-6745-9764
 www.quantel-global.com
 sales@quantel-global.com